

PRECISION

WEATHER

INSTRUMENTS

INTRODUCING

Vantage Pro2™

- Transmits weather data wirelessly up to 1000'!
- Over 3 times the distance of competing stations!



**TECHNOLOGY
BREAKTHROUGH!**

The first & only weather stations
in their class to use frequency hopping
spread spectrum radio technology.

DAVIS 
Davis Instruments

What's New?

Vantage Pro2. Over 3 times the transmission distance, improved reception through multiple walls, and greater immunity from RF interference. **Pages 2–9.**

USB Version of WeatherLink. Our popular data logger and software package is now available with USB. **Page 12.**

Streaming Data Loggers. New WeatherLink models specially designed for emergency response teams, ham radio operators, and irrigation control. **Page 13.**

CarChip. Sophisticated data logging technology put to a new use. Find out how your teen is driving, or how your car's engine is performing. **Page 23.**

On Our Cover

Daytime Fan-Aspirated Radiation Shield Kit. Nearly 75% as effective as our 24-hour radiation shields, at half the cost. **Page 7.**

Original Vantage Pro

Because it uses a different radio, Vantage Pro2 is not compatible with our original Vantage Pro stations. If you've been thinking about adding to your current system, act now while original Vantage Pro is still available. Visit our Clearance Center at www.davisnet.com.

As always, please contact one of our customer service representatives if you have any questions. We're always glad to help.

(510) 732-9229 Main telephone line.

(510) 732-7814 For answers to technical questions or help with trouble-shooting.

(510) 670-0589 Fax to Customer Service or Tech Support.

www.davisnet.com Visit our web site.

sales@davisnet.com E-mail to Customer Service.

support@davisnet.com E-mail to Technical Support.

info@davisnet.com General e-mail.



The GLOBE Program

Students of all ages can participate in the worldwide GLOBE program with the new protocols developed just for Davis weather stations. See www.globe.gov.

GLOBE, The GLOBE Program, and the GLOBE logo are trademarks of the U.S. Government. Use of these trademarks and certification by this company that its products conform to specifications of The GLOBE Program do not imply endorsement of this company or its products by the U.S. Government.

With Vantage Pro2, our wireless weather stations are now even better than ever. The first and only stations in their price range to use frequency hopping spread spectrum radio, our wireless Vantage Pro2s transmit and receive data up to 1000' (300 m) line of sight. That's over three football fields in length—and three times farther than competing stations! At the same time, we've kept all the features that have made Vantage Pro famous. You'll get highs and lows (and/or totals or averages) for virtually all weather variables for the last 24 days, months, or years, and your own local forecast—all without a PC.

Graph icon shows which function is currently being displayed on the graph.

View current data or highs and lows for up to 24 different days, months, or years.

Inside compass rose, view wind direction to 1° resolution. Or view wind speed.

Compass rose with 16 compass points shows current and dominant wind direction.

Set over 70 alarms for multiple functions simultaneously. Alarm bell indicates that alarm is set.

Graph last 24 hours, days, or months of readings or highs and lows. View over 80 graphs including additional analysis of temperature, rain, rain rate, wind, and barometric pressure. All without a computer!

Vertical scale changes depending on what you are graphing.

Look for the following logos throughout the catalog:

 Identifies the stations or sensors that may be NIST certified. See page 16 for details.

 Identifies stations suitable for use with the GLOBE protocol.

Ticker-tape display shows expanded forecast details and additional information on current conditions. Over 100 different messages!

- Vantage Pro2™ Features:**
- Large 3½" x 6" (9 x 15 cm) LCD screen.
 - Backlit display for easy viewing.
 - U.S. and metric units of measure.
 - Optional WeatherLink data logger and software for even more analysis.

Forecast icons let you know whether to expect sun, part sun, clouds and rain, or snow.

Eight phases of the moon, from new moon through full moon.

Time and date fields let you view:

- Time of sunrise and sunset
- Current time and date
- Time and date of highs and lows
- Time and date of graphed data point

New longer antenna for frequency hopping spread spectrum radio, for better reception and more than twice the distance—up to 1000' (300 m) line of sight!

Five-position trend arrow shows whether barometric pressure is rising, falling, or stable.

Fixed display area shows the most important weather variables at all times.

Variable display area lets you pick between:

- Inside or additional temperatures or soil moisture
- Inside or additional humidity, UV index, or leaf wetness
- Wind chill, dew point, or two different heat indices

Plus and minus keys simplify data entry.

Use arrow keys to scroll through data on graph or view highs and lows over time.

View daily rain or rain for this storm.

Umbrella icon appears when it is currently raining.

View monthly or yearly rainfall, rain rate, evapotranspiration, or intensity of solar radiation.

Blinks to let you know that data is being received.

Optional sensors or stations are required to view additional temperatures or humidities, soil moisture, UV index, solar radiation, and evapotranspiration.

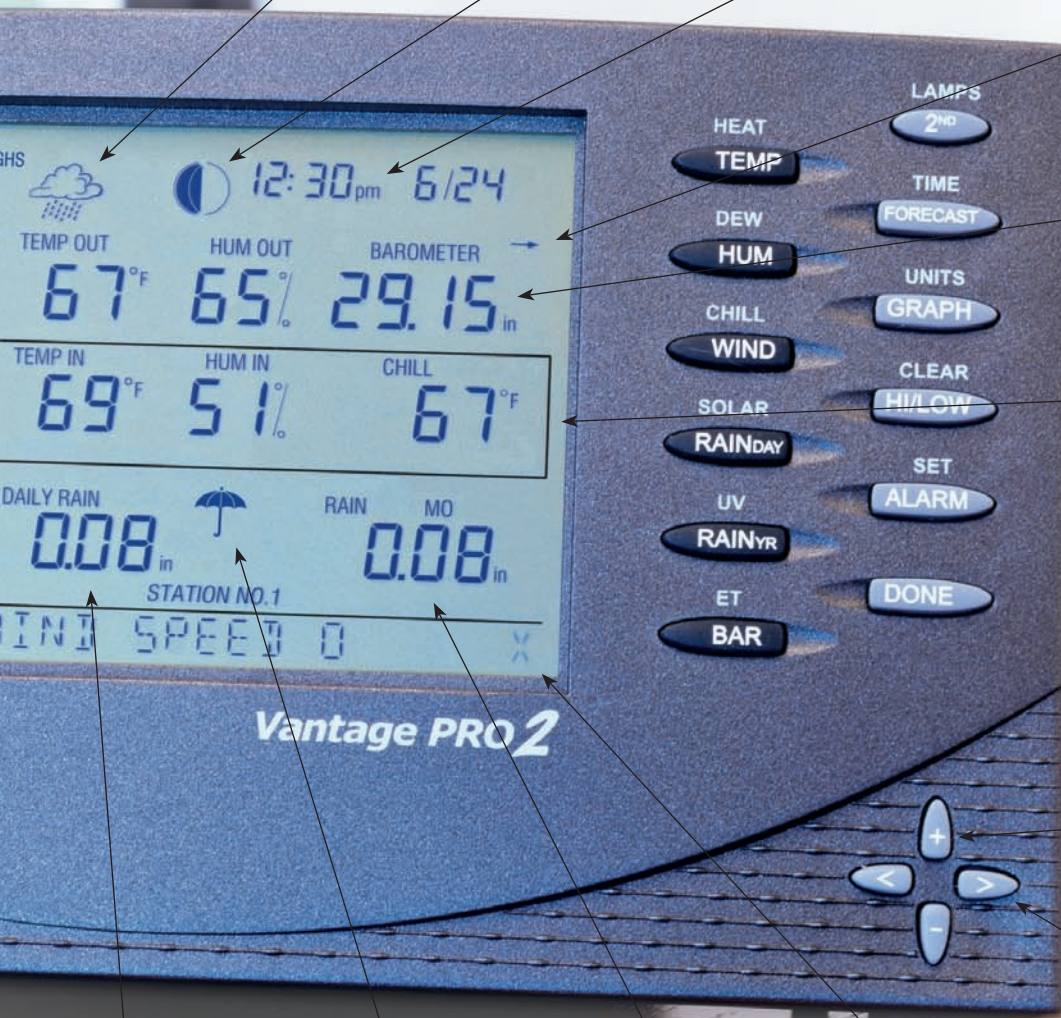

Vantage Pro2

Vantage Pro2™ weather stations are available in both wireless and cabled versions. All include our innovative integrated sensor suite, which combines our rain collector, temperature and humidity sensors, and anemometer all into one package—making setup easier than ever and improving performance and reliability. Customize your weather station by adding additional consoles or one or more of the special-purpose stations shown on the following pages. *Because regulations vary, wireless stations may not be available outside the USA.*

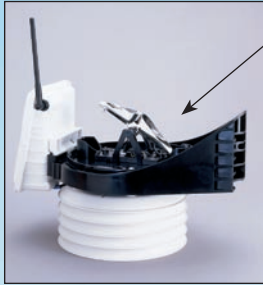

Designed to meet the guidelines of the World Meteorological Organization, our aluminum-plated **tipping bucket** is corrosion-resistant and laser-calibrated for accuracy.

Anemometer includes both wind speed and wind direction sensors. Rugged components stand up to hurricane-force winds, yet are sensitive to the lightest breeze. Wind-tunnel tested to speeds in excess of 170 miles per hour (274 km/h).

Rain collector with self-emptying tipping bucket is exceptionally accurate. Read rainfall amounts in 0.01" or 0.2 mm increments.

Weather-resistant shelter houses electronic components for added protection against the elements.

Wireless integrated sensor suite runs on solar power. Lithium battery provides backup at night and during cloudy, wintry days. (Solar panel is not included with cabled version.)

Models with **24-Hour Fan-Aspirated Radiation Shields** include additional radiation shield plates and a second solar panel, which powers the motor-driven fan.

Temperature and humidity sensors are located inside the radiation shield. The shield protects the sensors from solar radiation and other sources of radiated and reflected heat.

Optional Mounting Pole is just one of several installation options. For more, see the fence-post installation and the mounting tripod on page 6.

6153 Wireless Vantage Pro2 with 24-Hour Fan-Aspirated Radiation Shield



All Vantage Pro2™ stations include:

- Console with AC-power adapter. Wireless console may also be run using three C batteries. Batteries should also be added to cabled console for backup during power outages.
- Integrated sensor suite with rain collector, temperature and humidity sensors, and anemometer.
- 40' (12 m) anemometer cable.
- Mounting hardware.



Vantage Pro2 Plus™ stations also include:

- Solar radiation sensor.
- UV radiation sensor.
- Sensor mounting shelf.

Cabled stations also include:

- 100' (30 m) cable from console to integrated sensor suite.

Wireless stations also include:

- Transmitter (in weather-resistant shelter) and receiver (in console). Range is up to 1000' (300 m) outdoors, line of sight. Typical range through walls under most conditions is 200' to 400' (60 to 120 m).
- Ability to receive data from more than one transmitter. See the chart on page 17 for the maximum number of each station type.
- Ability to retransmit from one console/receiver (or wireless Weather Envoy) to another, so you can view the same weather data in more than one location.

Our temperature sensors have an accuracy of $\pm 1^\circ\text{F}$ (0.5°C), and the accuracy of our outside humidity sensors is $\pm 3\%$. In real-life situations, though, solar radiation and the reflected heat from rooftops or pavement can result in greater variances. The radiation shields included with our standard Vantage Pro2 and Pro2 Plus models provide considerable protection, but for even better accuracy—especially on warm, sunny days with little or no wind—choose one of our fan-aspirated stations. The motor-driven fan draws air through the sensor chamber and exhausts it through the top of the shield. With this improved air flow comes improved temperature and humidity readings. The effects of radiated and reflected heat are minimized, and conditions inside the radiation shield come as close as possible to the ambient air conditions.

In side-by-side testing, our radiation shields beat or came close to matching the performance of equivalent models costing as much as seven times more. For details, see our study at www.davisnet.com/links.



NEW!

See page 16 for extension cables.

Vantage Pro2™

Our most popular station. Choose the wireless model for:

- Easiest installation.
- Ability to add additional consoles or special-purpose stations.
- Reduced risk of damage from lightning strikes.

Choose the cabled model for:

- Most economical installation.
- Field installation using our Complete System Shelter.

6152 Wireless Vantage Pro2
6152C Cabled Vantage Pro2



NEW!

See page 7 for details on UV and solar radiation sensors.

Vantage Pro2 Plus™

Includes all the features of Vantage Pro, plus everything you need for reading:

- UV index and dose.
- Solar radiation.
- Evapotranspiration.

UV and solar radiation sensors are pre-installed on sensor mounting shelf.

6162 Wireless Vantage Pro2 Plus
6162C Cabled Vantage Pro2 Plus



NEW!

Vantage Pro2™

with 24-Hour Fan-Aspirated Radiation Shield

Includes our patented solar-powered 24-hour fan-aspirated radiation shield for maximum accuracy of temperature and humidity readings, along with all the features of Vantage Pro2.

6153 Wireless Vantage Pro2 with 24-Hour Fan-Aspirated Radiation Shield

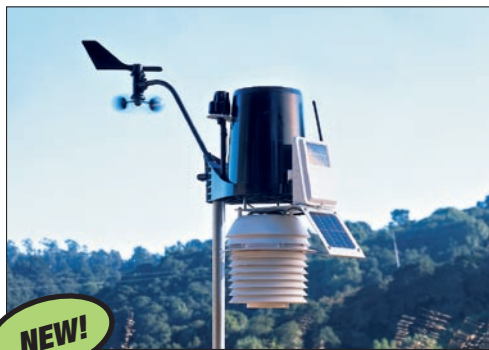

NEW!

Vantage Pro2 Plus™

with 24-Hour Fan-Aspirated Radiation Shield

Includes our patented solar-powered 24-hour fan-aspirated radiation shield for maximum accuracy of temperature and humidity readings, along with all the features of Vantage Pro2 Plus.

6163 Wireless Vantage Pro2 Plus with 24-Hour Fan-Aspirated Radiation Shield



24-Hour Fan-Aspirated Radiation Shield

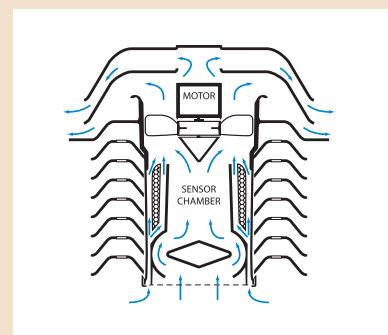

Motor-driven fan draws air through the sensor chamber 24 hours a day, 7 days a week. Air flow across the sensors is 500 feet per minute (2.5 m/s). At night, when the effects of radiation are less, the solar-powered model runs on battery power and the air flow is 280 feet per minute (1.4 m/s).

Vantage Pro2 Options

Build your own customized weather station by adding one or more of the options or special-purpose stations shown on the following pages. Each Vantage Pro2 console/receiver can receive data from up to eight different transmitting stations. Start with one of our wireless Vantage Pro2 or Vantage Pro2 Plus stations (which include both the console and the integrated sensor suite), and add up to seven additional Temperature or Temperature/Humidity Stations. Or buy the Vantage Pro2 console alone (without the integrated sensor suite), and add up to eight special-purpose stations of your choice. See the chart on page 17 for maximum number of each station type.



Use the console on a desk or at a table.



Or mount it on a wall.

Switch between metric and U.S. units of measure at the push of a button!

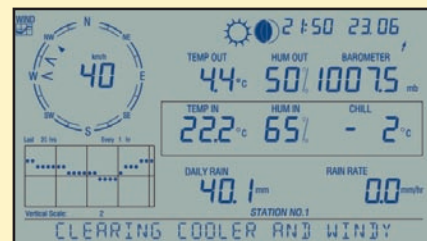
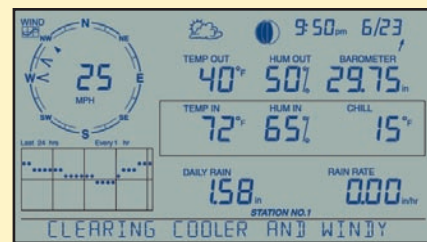

Flexible mounting options let you customize the installation to suit your needs.



40' (12 m) Anemometer Cable

All Vantage Pro2 stations, whether wireless or cabled, include a cable that lets you mount the anemometer and rain collector up to 40' (12 m) apart. When the cable is not needed, simply lash the coil out of the way on your mounting pole. Hardware for mounting on a pole or post is included; mounting pole is not.



Mounting Pole Kit

Optional Mounting Pole Kit includes two galvanized steel poles, connector, and mounting hardware. Poles measure 19½" (0.50 m) and 21" (0.53 m) long. Assemble the two together to make a single 37½" (0.95 m) long pole. Outside diameter is 1½" (33 mm).

7717 Mounting Pole Kit



Mounting Tripod

Optional tripod makes installation even easier. Brackets at the base of legs tilt to mount on roof or uneven terrain. Made of galvanized steel. Includes two 36⅜" (0.92 m)-long poles, which may be used separately or together to make a single 69¾" (1.77 m)-long pole.

7716 Mounting Tripod



NEW!

Anemometer Transmitter Kit

Solar-powered kit for use with wireless Vantage Pro2 or Vantage Pro2 Plus. Allows you to locate the anemometer independently from the rain collector, up to 1000' (300 m) away from the console/receiver. For longer distances, add one or more wireless repeaters. Kit includes transmitter inside weather-resistant shelter, solar panel, battery, and mounting hardware.

6332 Anemometer Transmitter Kit

Solar Radiation Sensor

To measure solar radiation and solar energy. Diffuser element and housing are carefully designed for accurate cosine response. Silicon photo diode provides good match to solar spectrum. Two-piece housing minimizes radiation heating, allows convection cooling of the sensor, and prevents the trapping of water or dust. To mount next to a rain collector, add our Sensor Mounting Shelf (not included).



6450 Solar Radiation Sensor

Includes 4' (1.2 m) cable. (When sold pre-installed on a Vantage Pro2 Plus, includes 3' (0.9 m) cable.) Use Standard 4-Conductor Extension Cable. Maximum cable length is 125' (38 m) from sensor to integrated sensor suite.
 7876-008 Cable, 8' (2.4 m) 7876-040 Cable, 40' (12 m) 7876-100 Cable, 100' (30 m)

UV Sensor

Measures the sunburning portion of the UV spectrum. Allows you to display UV index, dose rate, and daily and accumulated dose. Multi-layer filter provides a spectral response that closely matches the Erythema Action Spectrum. Diffuser provides excellent cosine response. Two-piece housing minimizes radiation heating, allows convection cooling of the sensor, and prevents the trapping of water or dust. To mount next to a rain collector, add our Sensor Mounting Shelf (not included).



6490 UV Sensor

Includes 4' (1.2 m) cable. (When sold pre-installed on a Vantage Pro2 Plus, includes 3' (0.9 m) cable.) Use Standard 4-Conductor Extension Cable. Maximum cable length is 125' (38 m) from sensor to integrated sensor suite.
 7876-008 Cable, 8' (2.4 m) 7876-040 Cable, 40' (12 m) 7876-100 Cable, 100' (30 m)



NEW!

Daytime Fan-Aspirated Radiation Shield Kit

An economical solution for adding the benefits of fan aspiration to your wireless or cabled Vantage Pro2 or Pro2 Plus. Half the cost of our 24-hour fan-aspirated radiation shield, but nearly 75% as effective in reducing the effects of daytime radiation. Solar-powered fan runs during the day. Since there is no backup battery, the fan will cease running when night falls and the effects of radiation are less. Kit includes fan, solar panel, additional radiation shield plates, and hardware, as shown in inset photo. Larger photo shows the kit as installed on a wireless Vantage Pro2. Note that this kit is not compatible with our original Vantage Pro stations. Kits for those stations may still be available; check our website for details and availability.

7747 Daytime Fan-Aspirated Radiation Shield Kit



Attaches easily to the outside of the Vantage Pro2 integrated sensor suite.

Sensor Mounting Shelf

For mounting Vantage Pro2 solar radiation and/or UV sensors. Rigid shelf with anodized aluminum posts and stainless steel hardware attaches easily next to the rain collector on the outside of the integrated sensor suite.

6673 Sensor Mounting Shelf



In Canton, Georgia, Andy and Angi Mills grow tomatoes, peppers, and okra with the help of a Wireless Leaf & Soil Moisture/Temperature Station.

Wireless Leaf & Soil Moisture/Temperature Station

Solar-powered station includes transmitter and battery inside weather-resistant shelter. To view the data, add a wireless Vantage Pro2 console/receiver, or Weather Envoy and WeatherLink. Each can receive data from *either*:

- A single fully-populated station with 2 leaf wetness sensors, 4 soil moisture sensors, and 4 temperature probes, *or*
- Two partially-populated stations, one with 2 leaf wetness sensors and 2 temperature probes, and the other with 4 soil moisture sensors and 4 temperature probes.

Available in two models. Choose the model without sensors, and add only those you need to meet your requirements. Or choose the Complete Soil Moisture/Temperature Station, and add one or two leaf wetness sensors as desired.

6345 Wireless Leaf & Soil Moisture/Temperature Station without sensors

6345CS Complete Soil Moisture/Temperature Station with 4 soil moisture sensors and 4 temperature probes

For teachers participating in the GLOBE program, see the special protocol developed for the 6345CS at www.globe.gov, or visit our website at www.davisnet.com/links.

NIST

Leaf Wetness Sensor

Use to monitor the level of surface moisture on foliage, with range from 0 (completely dry) to 15 (saturated). Add up to two sensors to a single Wireless Leaf & Soil Moisture/Temperature Station. Includes 40' (12 m) cable.

6420 Leaf Wetness Sensor



Soil Moisture Sensor

Watermark® soil moisture sensor uses electrical resistance to measure the moisture level of the soil. Does not require periodic maintenance during the growing season. Simply bury at the desired depth, then monitor moisture levels throughout the season. Add up to four sensors to a single Leaf & Soil Moisture/Temperature Station. Includes 15' (4.6 m) cable.

6440 Soil Moisture Sensor



Stainless Steel Temperature Probe

Multi-purpose temperature probe with 2½" (64 mm)-long stainless steel housing. Use to measure temperature of air, soil, or water. Add up four probes to a single Leaf & Soil Moisture/Temperature Station. Includes 15' (4.6 m) direct-burial cable.

6470 Stainless Steel Temperature Probe

NIST



Wireless Temperature/Humidity Station

Battery-powered station includes temperature and humidity sensors inside protective radiation shield, and transmitter and lithium battery inside weather-resistant shelter. Battery lasts up to one year under normal conditions. To view the data, add a wireless Vantage Pro2 console/receiver or Weather Envoy and WeatherLink. Includes hardware for mounting on fence post or pole. Mounting pole is not included.

6382 Wireless Temperature/Humidity Station

NIST



Wireless Temperature Station

Battery-powered station includes stainless steel temperature probe with 12' (2.6 m) cable, transmitter and battery inside weather-resistant shelter, and mounting hardware. To view the data, add a wireless Vantage Pro2 console/receiver, or Weather Envoy and WeatherLink. Battery lasts up to one year under normal conditions.

6372 Wireless Temperature Station

NIST

Recieve data from a Vantage Pro2 integrated sensor suite or special-purpose station, and post it to your computer—no console required! Weather Envoy, when used along with WeatherLink, will collect and store data from the outdoor sensors. Download to your computer at your convenience, then use the WeatherLink software to view current conditions, graph and chart historical data, or even create your own weather web pages.

NEW!

Weather Envoy™

Weather Envoy includes its own barometer and inside temperature and humidity sensors. Both the wireless and cabled versions include an AC-power adapter. Either may also be run using one of our solar power kits. The wireless model may also be run using three AAA batteries. Batteries will last up to six months, depending on the logging interval. Batteries should also be added to the cabled model for backup during power outages.

- 6316 Wireless Weather Envoy
- 6316C Cabled Weather Envoy

NIST

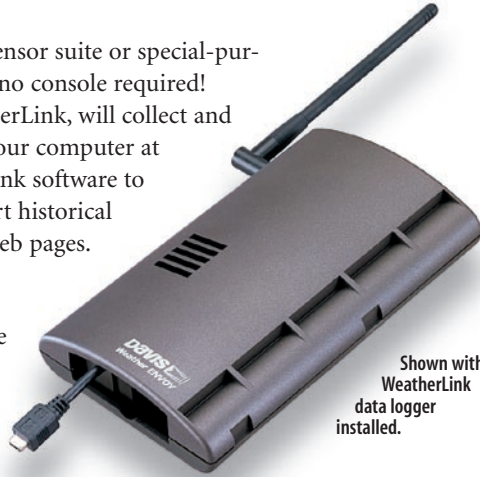

Shown with WeatherLink data logger installed.

Requires WeatherLink data logger and software package (not included). See pages 12–13.



NEW!

6328 with 24-Hour Fan-Aspirated Radiation Shield

Integrated Sensor Suite

For use with Weather Envoy and WeatherLink. Includes all the features of the Vantage Pro2 or Pro2 Plus integrated sensor suites shown on pages 4-6. Tripod not included.

NIST

Wireless Integrated Sensor Suite

- 6322 with Standard Radiation Shield
- 6323 with 24-Hour Fan-Aspirated Radiation Shield

Cabled Integrated Sensor Suite

- 6322C with Standard Radiation Shield

Wireless Integrated Sensor Suite Plus

- with UV and solar radiation sensors
- 6327 with Standard Radiation Shield
- 6328 with 24-Hour Fan-Aspirated Radiation Shield

Cabled Integrated Sensor Suite Plus

- with UV and solar radiation sensors
- 6327C with Standard Radiation Shield

Receive data directly from the outdoor sensors—no console required!

Install wireless or cabled Weather Envoy in your home or office, next to your computer for easy and convenient downloading. For field installation options, see page 17.

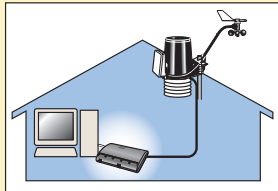

Cabled Home/Office Station

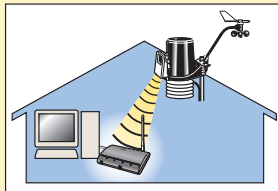

Wireless Home/Office Station

A cabled Weather Envoy can be used with ONE of the following:

- Cabled Integrated Sensor Suite, or
- Cabled Integrated Sensor Suite Plus

A wireless Weather Envoy can be used with ALL of the following:

- One wireless Integrated Sensor Suite or Integrated Sensor Suite Plus
- One Anemometer Transmitter Kit
- One Leaf & Soil Moisture/Temperature Station or one Soil Moisture/Temperature Station
- Three Temperature Stations or one Temperature Station and two Temperature/Humidity Stations.

Or use in addition to a wireless Vantage Pro2 console/receiver.

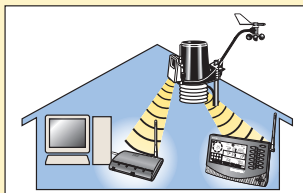

Transmit to Both Simultaneously

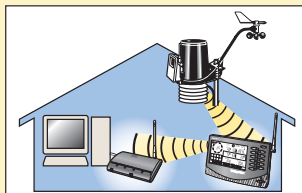

Retransmit Data to Weather Envoy

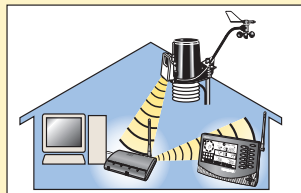

Retransmit from Weather Envoy

Wireless Repeaters

For longer distances or to improve reception in troublesome areas, add one or more wireless repeaters. Range is up to 1000' (300 m) outdoors, line of sight. Typical range through walls under most conditions is 200' to 400' (60 to 120 m). Use up to eight repeaters with a single wireless station, or form a network of weather stations by linking eight repeaters to eight different wireless stations. AC-powered model includes power adapter. Solar-powered model includes solar panel, regulator circuit, and rechargeable battery. Both models available Spring, 2005.

- 7626 Wireless Repeater, AC-Powered
- 7627 Wireless Repeater, Solar-Powered

NEW!

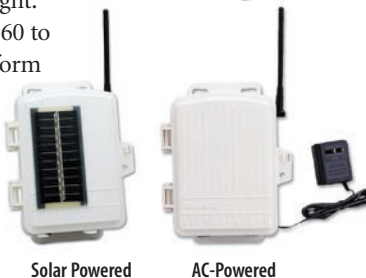

Solar Powered

AC-Powered



NEW!

Vantage Pro2 Console/Receiver

To view data from a wireless Vantage Pro2 station in additional locations, or for use with any of the special-purpose wireless stations shown on the previous pages. Includes all the features shown on pages 2-3.

NIST

- 6312 Vantage Pro2 Console/Receiver

Weather Wizard III & Monitor II

Our Weather Wizard III and Weather Monitor II offer sophisticated, professional quality for home, business, or scientific use. Add WeatherLink for detailed, long-term analysis using your PC, and you'll have a powerful computer weather station at a surprisingly affordable price.

See the "Options & Accessories chart on page 18 for a complete look at which options may be used with which station.



Weather Monitor II®

A full-featured weather station. Basic model includes barometric pressure, inside and outside temperature, inside humidity, wind speed and direction, and wind chill. With the complete station, you'll also get outside humidity, dew point, and daily and accumulated rainfall.

7440 Weather Monitor II

7440CS Complete Weather Monitor II

with rain collector and temperature/humidity sensor

NIST



Perception II®

An indoor weather station requiring no installation—just plug it in using the included AC-power adapter. Use to monitor your wine cellar, greenhouse, or other climate-dependent area. Measures temperature, humidity, and barometric pressure. So accurate, it's even used by automobile racers to tune their carburetors for current air density conditions. Backlit display for easy viewing.

NIST

7400 Perception II



Rain Collector

Designed to meet the guidelines of the World Meteorological Organization, our self-emptying tipping-bucket design is exceptionally accurate. Measures in 0.01" or 0.2 mm increments.

7852 Rain Collector for Wizard or Monitor

Includes 40' (12 m) cable. Use Standard 4-Conductor Extension Cable. Maximum cable length is 900' (270 m) from rain collector to console including junction box cable.

7876-008 Cable, 8' (2.4 m)

7876-100 Cable, 100' (30 m)

7876-040 Cable, 40' (12 m)

7876-200 Cable, 200' (60 m)

NIST

Temperature/Humidity Sensor

Measures outside temperature, relative humidity, and dew point. For use with Weather Monitor II. Replaces the external temperature sensor included with the station.

7859 Temperature/Humidity Sensor for Monitor

Includes 40' (12 m) cable. Use Standard 6-Conductor Extension Cable. Maximum cable length is 300' (91 m) from sensor to console including junction box cable.

7878-040 Cable, 40' (12 m)



NIST

Perception II, Weather Wizard III, & Weather Monitor II



7440CS Complete Weather Monitor II

All stations include the following features:

- Time in 12- or 24-hour format and date.
- U.S. and metric units of measure.
- Highs and lows.
- Sequential scan and display of readings.
- Alarms for selected functions.
- Calibration of some functions for increased accuracy under difficult conditions.
- Backlighting of LCD display for easy viewing (except Weather Wizard III).

All stations include the following components:

- Console with reversible base for use on desk, shelf, or wall.
- AC-power adapter with battery backup (battery not included).
- Quick and easy plug-in cable connections using modular RJ connectors like those found on your telephone.

Wizard & Monitor stations also include:

- Anemometer for wind speed and direction
- Outside temperature sensor
- Junction box with 8' (2.4 m) cable to connect sensor cables to console.

Optional components include:

- Rain collector (for Wizard or Monitor)
- Temperature/humidity sensor (for Monitor only)

Extension cables:

Be sure to use the appropriate extension cable listed for each component. See the complete chart on page 16. Although the RJ connector may fit, most standard telephone extension cords are not compatible.



Weather Wizard III®

The most-requested features at an economical price. Basic model includes inside and outside temperature, wind speed and direction, and wind chill. With the complete station, you'll also get daily and accumulated rainfall.

7425 Weather Wizard III

7425CS Complete Weather Wizard III with rain collector



Radiation Shield

The most effective passive shelter available. Protects temperature sensor from solar radiation and other sources of radiated and reflected heat. Multi-plate construction for maximum airflow. Assembly required.

7714 Radiation Shield

for Wizard or Monitor, or for Wireless Temperature Station or Leaf & Soil Moisture/Temperature Station



Rain Collector Shelf

Provides a horizontal surface for mounting the Rain Collector. May be used with Sensor Mounting Arm or mounted on other structures or surfaces. Aluminum shelf is white powder coated for added durability.

7704 Rain Collector Shelf



Sensor Mounting Arm

For use with Weather Wizard III or Weather Monitor II. Aluminum arm is white powder coated for added durability. Includes mounting hardware and ground wire.

7702 Sensor Mounting Arm



Link Isolator Kit

For upgraded protection against electrical disturbances, install the Link Isolator between the WeatherLink data logger and your computer. Includes 40' (12 m) cable and power adapter. For use with WeatherLink models 7862 or 7855 only. For other models, equivalent protection is already built in.

7764 Link Isolator Kit



Protected Junction Box

Provides upgraded protection against the electrical disturbances that can come through sensor cables, including radio frequency interference, electrostatic discharges, and voltage surges. Includes two 16' (5 m) ground wires. For use with Weather Monitor II or Weather Wizard III only.

7740 Protected Junction Box



Choose the station that suits your needs	Perception II	Weather Wizard III	Complete Weather Wizard III	Weather Monitor II	Complete Weather Monitor II
Barometric Pressure	●			●	●
Inside Temperature	●	●	●	●	●
Outside Temperature		●	●	●	●
Wind Direction		●	●	●	●
Wind Speed		●	●	●	●
Wind Chill		●	●	●	●
Rainfall		Optional	●	Optional	●
Inside Humidity	●			●	●
Outside Humidity				Optional	●
Dew Point				Optional	●

Wizard and Monitor calculate and display wind chill according to the original National Weather Service Formula. A new formula was adopted in 2001. For wind chill using this formula, view the data using WeatherLink or choose Vantage Pro2 instead.

For the ultimate in weather monitoring, add WeatherLink to any of our weather stations. The data logger fits neatly into the weather station console or Weather Envoy, storing weather data even when it's not connected to your PC. Later, download the data and use the software for detailed analysis and graphing.

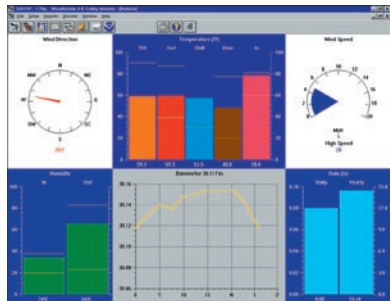

See current conditions at a glance on the instant weather bulletin.

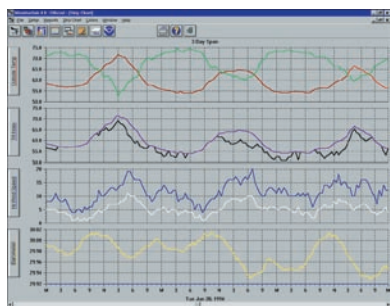

Graph data on a daily, weekly, or yearly basis.

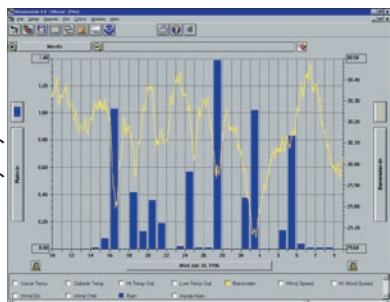

View multiple weather variables at the same time to see their relationships.

NASA and NSF. See www.globe.gov.

- **Weather World 'Round.** Send your URL to news@davisnet.com and we'll add it to our growing list of Davis stations around the world. See www.davisnet.com/links.

Expanded Reporting

- **Expanded Temperature Reporting.** Heating degree days, cooling degree days, and fuel-oil demand.
- **Optional Sensor Reporting.** Evapotranspiration, leaf wetness, soil moisture, soil temperature, sunburn risk for each skin type, and solar energy.
- **Weather Watcher Reports** in NOAA National Climatic Data Center format.

Weather Website

Create your own weather website or post weather conditions to a LAN. Use our included HTML templates or design your own. Add graphs, text lines, or scrolling ticker tapes, and upload other files (such as images from a webcam) along with your weather data.

New Features

Our latest versions of WeatherLink include a host of new and improved features.

- **Weather Forecast.** Lets you know what to expect, with quick-view icons for the forecast at a glance and text messages for expanded details.
- **Moon Phase.** With eight phases of the moon, from new moon through full moon.
- **Updated Wind Chill.** Uses the new formula adopted by the National Weather Service which incorporates modern heat transfer theory and a lower calm wind threshold.

Sharing Your Weather Data

WeatherLink makes it easy for you to participate in a number of worthwhile programs including:

- **The Citizen Weather Observer Program.** Your data, submitted via APRS or the Internet, can help the National Weather Service develop improved weather prediction models. See www.wxqa.com.
- **The GLOBE Program.** An international weather-related science program for students from elementary through high school, supported by



In Spain, a network of twelve Vantage Pro Plus stations form the Meteorological Educational Network of Cataluña. For more about the program, visit www.xtec.es/edumet.

WeatherLink with Standard Data Logger

With our standard data logger, you choose the logging interval: every 1, 5, 10, 15, 30, 60, or 120 minutes. Depending on the logging interval, you can store up to six months of data before downloading. (Up to four months for Perception, Wizard, or Monitor.) Set the system to download automatically every day, or download manually whenever you like. After downloading, use the included software for detailed analysis and graphing, or export the data to most popular spreadsheet, database, and word processing programs. Available in five models; be sure to choose the model that is right for your system.



Vantage Pro2 Data Logger

WeatherLink for Vantage Pro2

- 6510USB USB version for Windows 98SE/2000/ME/XP
- 6510SER Serial port version for Windows 95/NT4.0/98/2000/ME/XP
- 6510X Extra User License Kit for 6510USB, 6510SER, 6540, 6550, or 6560

- 6520 Mac version for Mac OS X v 10.1 or above
- 6520X Extra User License Kit for 6520

Includes USB version of data logger. Unlike the Windows version, does not log data from leaf wetness, soil moisture, solar radiation, or UV sensors. Also does not include the Citizen Weather Observer, GLOBE Program, Expanded Temperature Reporting, or Optional Sensor Reporting capabilities.

WeatherLink for Perception, Wizard, or Monitor

- 7862 Serial port version for Windows 95/NT4.0/98/2000/ME/XP
- 7862X Extra User License Kit

- 7855 Mac version for Mac OS X v 10.1 or above

7855X Extra User License Kit
Requires a USB serial adapter. Does not include any of the features listed above under 6520 and 6520X. Also does not include the Weather Forecast or Moon Phase features.

All WeatherLinks with Standard Data Loggers include:

- Software on CD
- Data logger
- 8' (2.4 m) cable to connect the data logger to your computer

Extra User License Kits include:

- Software on CD
- Extra user license

To track multiple stations on the same computer, add one WeatherLink for each station. To view the data from the same weather station on multiple computers, add one Extra User License Kit for each computer.

WeatherLink is now available in models specially designed to meet the needs of emergency response teams, ham radio operators, and anyone concerned with irrigation control—from home owners with automatic sprinklers to growers running sophisticated irrigation control systems. Each new WeatherLink model includes one of our new streaming data loggers, which provide a continuous stream of data from your Vantage Pro2 or Pro2 Plus to your PC, TNC modem, or irrigation controller. Each also simultaneously logs and stores the data, which can later be downloaded to your PC for all the WeatherLink graphing, charting, and analysis described on the previous page.



NEW! Ham radio operator Keith LaBorde, of Marietta, Georgia, posts weather conditions from his Vantage Pro to his website, www.qsl.net/wd5bjq.

WeatherLink for APRS with Streaming Data Logger

For ham radio operators, including storm chasers and volunteer weather watchers. Connects a Vantage Pro2 console or Weather Envoy to a TNC modem for instant transmission of both your location and the local weather conditions via APRS (Automatic Position Reporting System). Data submitted via APRS lets emergency personnel map changing weather conditions in real-time, and also helps the National Weather Service develop improved weather prediction models.

6540 WeatherLink for APRS

TNC (Terminal Node Controller) modems translate the data from Vantage Pro2 into packets for transmission via ham radio.

All WeatherLinks with Streaming Data Loggers include:

- Software on CD
- Streaming data logger
- 8' (2.4 m) cable to connect the data logger to your computer or modem.

For downloading to PC, all models require Windows 95/NT4.0/98/2000/ME/XP and one free serial port.

Irrigation control model connects directly to controller. Connection to a PC is not required unless you also wish to download the data to WeatherLink.

For Extra User License Kit, see 6510X on page 12.

WeatherLink for Emergency Response Teams with Streaming Data Logger

NEW! For use with the free CAMEO® software developed by NOAA and the EPA. With Vantage Pro2, provides the real-time weather data needed to map the “footprint” of a hazardous plume, predict its dispersion, and help make critical public safety decisions—all at just a fraction of the cost of other systems.

6550 WeatherLink for Emergency Response Teams

CAMEO, or Computer-Aided Management of Emergency Operations, is a suite of three integrated software applications, including ALOHA® Areal Locations of Hazardous Atmospheres. For more about CAMEO and ALOHA, visit www.epa.gov/ceppo/cameo.



E-Mail/Phone Alert Module

Be alerted whenever conditions approach critical—24 hours a day, 7 days a week. Choose e-mail for detailed information on alarm conditions plus regularly scheduled updates on current weather conditions. Or choose the phone alert, with a special alarm tone telling you to check your weather station console or WeatherLink for details.

6512 E-Mail/Phone Alert Module

For use with WeatherLink 6510USB, 6510SER, 6540, 6550, 6560, or 7862. Because systems vary, the phone alert may not work outside the USA.



WeatherLink for Irrigation Control with Streaming Data Logger

NEW! Use your Vantage Pro2 to turn your irrigation system on or off based on current weather conditions—no more watering the lawn when it's raining! Installation is quick and easy. Connects to most common irrigation systems, including Rain Bird, Rain Master, and Toro. For the industrial controllers used in agriculture and turf management, provides electronic pulses for wind, rain, and evapotranspiration. For homeowners, uses the alarm settings in the Vantage Pro2 console. Set the alarms to water your garden before a hard freeze hits, or to turn the system off if it starts raining. Add our optional solar radiation sensor, and you can even set the alarms to turn the system on or off based on evapotranspiration.

6560 WeatherLink for Irrigation Control

May also be used to control thermostats or other low-voltage devices. To switch power to heaters, motors, or other high-power equipment, you will need to add electrical relays (not available from Davis Instruments).



Eugene Kramer, coordinator of the Emergency Services & Disaster Agency in Freeburg, Illinois, relies on Vantage Pro for critical real-time data on weather conditions.



On his 1400-acre corn and soybean farm in Iowa, Al Schafbuch uses WeatherLink to track degree days and rainfall.

For use with WeatherLink 6510USB, 6510SER, 6540, 6550, 6560, or 7862. Some reports require the use of optional sensors. For owners of GroWeather who wish to upgrade to Vantage Pro2, includes the ability to import files from GroWeatherLink.

Agricultural/Turf Management Module

Optional software module adds specialized reports for farmers, growers, and turf managers, with user-defined growing season and 24-hour period. You'll get evapotranspiration, chilling requirement, leaf wetness hours, and soil temperature hours—all with user-entered thresholds and starting and ending dates. Plus growing degree-days and temperature-humidity hours (with user-entered names of crops, pests, or diseases) and crop water management (with irrigation values and user-entered K-factor profiles).

6511 Agricultural/Turf Management Module

Telephone Modem Adapter

For transmission of data from any of the serial port versions of our WeatherLink data loggers using a modem.

Telephone Modem Adapter

6533 for WeatherLink for Vantage Pro2
7870 for WeatherLink for Wizard/Monitor



WeatherLink Downloader for Palm PDA

Use to download data from a WeatherLink data logger into your Palm™ Pilot or compatible PDA, for later transfer to your PC. Kit includes 9-pin cable adapter and software on CD. For PDAs with Palm OS 3.5.1 to 5.x and serial interface. For use with WeatherLink models 6510SER, 6540, 6550, or 6560. Not for use with 6510USB.



6538 WeatherLink Downloader

Vantage Pro2 Updater

Take advantage of the latest developments with our Vantage Pro2 Updater. Simply plug the Updater into the expansion port on your Vantage Pro2 console (where the WeatherLink data logger plugs in), and press the start button. The console will be automatically updated with the latest version of the firmware. Future updates may be downloaded from our website at no charge.

6311 Vantage Pro2 Updater



Rain Collector Heater



For use in cold climates to measure freezing rain or the moisture content of snowfall. Requires access to AC power; may not be run using a solar power kit. Includes 24-watt, 24-volt heater with thermal cut-off switch,

control unit, insulating reflective blanket, and AC-power adapter.

7720 Rain Collector Heater

Includes 50' (15 m) cable. Use Shielded 4-Conductor Extension Cable. Maximum cable length is 120' (36 m).
7895-050 Cable, 50' (15 m) 7895-100 Cable, 100' (30 m)

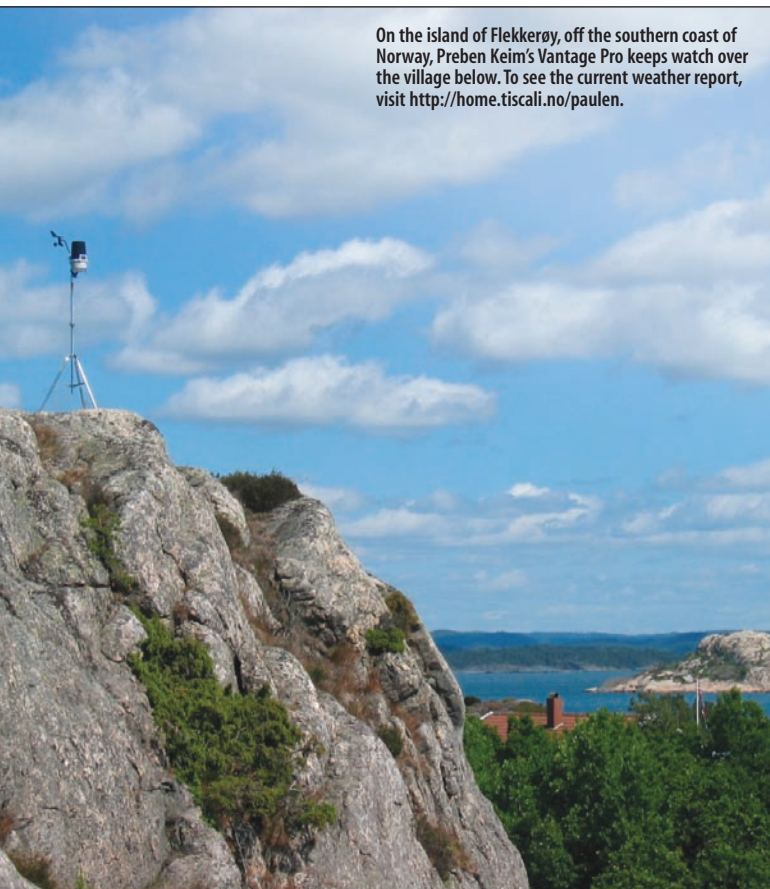

On the island of Flekkerøy, off the southern coast of Norway, Preben Keim's Vantage Pro keeps watch over the village below. To see the current weather report, visit <http://home.tiscali.no/paulen>.

Complete System Shelter

To locate your station console and other components outside, at a field or remote location. Weather-resistant NEMA 4X enclosure provides protection from the elements for any of the following:

- Vantage Pro2 console or console/receiver with WeatherLink data logger.
- Weather Wizard III or Weather Monitor II console with WeatherLink data logger, protected junction box, regulator circuit from solar power kit, and 7.0-amp-hour battery.

Measures 15½" × 7¾" × 13½" (395 × 195 × 345 mm).

7724 Complete System Shelter



Complete System Shelter with Vantage Pro2 console.

Multi-Purpose Shelter

Use to shelter any of the following sub-systems:

- Weather Envoy with WeatherLink data logger.
- Weather Wizard III or Weather Monitor II console with WeatherLink data logger and protected junction box.

Measures 3¾" × 9½" × 12½" (95 × 240 × 320 mm).

7728 Multi-Purpose Shelter



Multi-Purpose Shelter with Weather Envoy.



Solar Power Kit for Wireless Vantage Pro2 or Wireless Weather Envoy

Powers the wireless console/receiver or Weather Envoy. (Outdoor sensors are powered by the solar panel that is included with the station.) Includes solar panel, regulator circuit, rechargeable battery, and 20' (6 m) cable.

6610 Solar Power Kit for Wireless Vantage Pro2



Solar Power Kit for Cabled Vantage Pro2 or Cabled Weather Envoy

Powers both the console (or Weather Envoy) and the outdoor sensors. Includes solar panel, regulator circuit, rechargeable battery, and 16' (4.9 m) cable.

7707 Solar Power Kit for Cabled Vantage Pro2

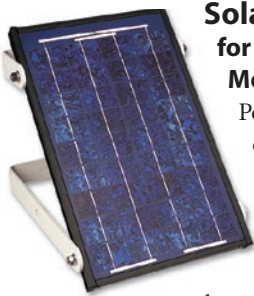

Solar Power Kit for Weather Wizard III or Weather Monitor II

Powers both the console and the outdoor sensors. Generates enough power to run the station under most low-light conditions. After one hour of bright sunlight, will supply sufficient energy to run the station for 16 hours in total darkness.

Dual-bracket design provides stability in winds up to 140 mph (225 km/hr). Includes 10-watt solar panel, regulator circuit, and battery mounting bracket. Use with our 7.0-Amp Hour Battery or other battery of your choice.

7708 Solar Power Kit for Wizard or Monitor

7.0-Amp-Hour Battery

For use with our 7708 Solar Power Kit. When fully charged, the battery will run the system for eight days at 68°F (20°C) or five days at -4°F (-20°C).



7711 7.0-Amp-Hour Battery

Car/Boat/RV Lighter Cord

For powering any of our weather station consoles or console/receivers. Plugs directly into the cigarette lighter in your car, truck, RV, or boat. Replaces the AC-power adapter that is included with the station. Includes 8' (2.4 m) cable.

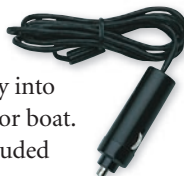

6604 Car/Boat/RV Lighter Cord for Vantage Pro2

7873 Car/Boat/RV Lighter Cord for Wizard or Monitor

WindScribe™

Ultrasonic wind meter uses patented technology to read current wind speed, highest positive speed (headwind), lowest negative speed (tailwind), 5-second average, and running average. Select from mph, km/h, fpm, m/s, f/s, or knots, plus temperature and wind chill in tenths of °F or °C. Sensitive to breezes as low as 0.4 mph, yet withstands winds as high as 150 mph. Includes replaceable 3-volt lithium battery. Battery lasts up to 600 hours. Dimensions: 5" × 3" × 3/4" (12.7 × 7.6 × 1.9 cm). Weight: 3 1/2 oz (100 grams).

276 WindScribe

NIST



Use Three Ways



Handheld with adjustable lanyard.



Tripod mount with 1/4" thread.



Mounting bracket with Velcro® strap.

Hand-Held Wind Speed Indicators

For instantaneous wind speed readings, where you need them, when you need them. Rugged, high-impact plastic with corrosion-resistant components, protective vinyl case, and attached wrist lanyard.

Wind Wizard™

Reads wind speed in miles/hour, meters/second, and Beaufort. Readout dial is supported on sapphire jewel bearings and steadied by a rare-earth magnetic dampening system. Folding handle quickly and securely latches into place. No batteries needed. Dimensions: 3 5/8" × 2 7/8" × 1" (92 × 73 × 25 mm) with handle folded. Weight: 2.5 oz (71 g).

281 Wind Wizard



Turbo Meter™

Reads wind speed in miles/hour, knots, feet/minute, or meters/second. Turbine suspended on sapphire jewel bearings responds to the lightest of winds. Three-digit display offers excellent viewing contrast in bright sunlight or at night. Requires three AAA alkaline batteries (not included). Dimensions: 4 5/8" × 2 5/8" × 1 1/8" (118 × 66 × 30 mm). Weight: 3 oz (85 g) not including batteries.

271 Turbo Meter



NIST

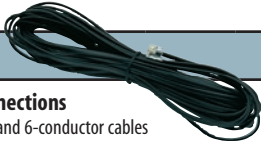

Extension Cables

Cable Connections

Standard 4- and 6-conductor cables include waterproof coupler kits for joining two cables together, indoors or out. To join standard 8-conductor cables, use an 8-pin cable coupler (for indoor use only). All cables may also be joined using Surge Protectors.

WeatherLink

The extension cables listed are for the serial port versions of WeatherLink. For USB versions of WeatherLink, add a USB extension cable, available from your local computer supplier. (Not available from Davis Instruments.)

Solar Radiation & UV Sensors

When sold separately, solar radiation and UV sensors include a 4' (1.2 m) cable. When sold pre-installed on a Vantage Pro2 Plus, the cable length is 3' (0.9 m).

Anemometer

For Wizard and Monitor, maximum wind speed reading decreases as length of cable from anemometer to console (including junction box cable) increases. At 140' (42 m), maximum speed is 175 mph (78 m/s). At 240' (73 m), maximum is 140 mph (62 m/s). At 340' (103 m), maximum is 70 mph (31 m/s). The accuracy of readings below the maximum is not affected.

7876-008 Standard 4-Conductor, 8' (2.4 m)	7876-040 Standard 4-Conductor, 40' (12 m)	7876-100 Standard 4-Conductor, 100' (30 m)	7876-200 Standard 4-Conductor, 200' (61 m)	7878-040 Standard 6-Conductor, 40' (12 m)	7880-025 Standard 8-Conductor, 25' (7.5 m)	7880-050 Standard 8-Conductor, 50' (15 m)	7880-100 Standard 8-Conductor, 100' (30 m)	7959 Eight-Pin Cable Coupler	7895-050 Shielded 4-Conductor, 50' (15 m)	7895-100 Shielded 4-Conductor, 100' (30 m)
---	---	--	--	---	--	---	--	------------------------------	---	--



Anemometers are wind-tunnel tested in our California factory.

Included Cable Length		Maximum Cable Length	Extension Cable to Use
Vantage Pro2	Wireless Vantage Pro2	40' (12 m)	540' (165 m) from anemometer to integrated sensor suite.
	Cabled Vantage Pro2	40' (12 m)	540' (165 m) from anemometer to integrated sensor suite.
		100' (30 m)	1000' (300 m) from console to integrated sensor suite.
	WeatherLink for Vantage Pro2	8' (2.5 m)	48' (14.6 m) from data logger to serial port.
	Solar Radiation Sensor	4' (1.2 m)	125' (38 m) from solar radiation sensor to integrated sensor suite.
UV Sensor	4' (1.2 m)	125' (38 m) from solar radiation sensor to integrated sensor suite.	
Wizard & Monitor	Weather Wizard III	8' (2.4 m)	125' (38 m) from junction box to console.
	Weather Monitor II	8' (2.4 m)	125' (38 m) from junction box to console.
	Protected Junction Box	None	200' (60 m) from Protected Junction Box to console.
	WeatherLink for Wiz/Mon	8' (2.4 m)	50' (15 m) from data logger to serial port.
	Anemometer	40' (12 m)	See note above.
	Rain Collector	40' (12 m)	900' (270 m) from rain collector to console, including cable from junction box to console.
	Temperature Sensor	25' (7.6 m)	300' (91 m) from sensor to console, including cable from junction box to console.
	Temp/Humidity Sensor	40' (12 m)	300' (91 m) from sensor to console, including cable from junction box to console.
Rain Collector Heater	50' (15 m)	120' (36 m) from power unit to AC-power adapter. Requires terminal block.	

NIST-Traceable Sensors

In the USA, the National Institute of Standards & Technology (NIST) develops and maintains the standards of measurement to which all others are ultimately traced. Numerous calibrations, tests, and measurement assurance programs are delivered directly to about 10,000 companies. From these companies, NIST-traceable intermediate service providers are the next link in a network that joins together the makers and users of precision instruments. Davis Instruments is proud to participate in this network. Each of our weather stations is carefully manufactured in our California factory. For those users who require NIST-traceability, certification and recertification of new and previously owned sensors is now available. Call, fax, or e-mail us for complete details.

Station Dimensions		Inches	Millimeters
Vantage Pro2	Console	9½ × 6 × 1½	240 × 150 × 38
	LCD Display	6 × 3½	150 × 90
	ISS: Anemometer Side	14½ × 5¼ × 17½	370 × 130 × 445
	ISS: Rain Collector Side with Standard Radiation Shield	11 × 9 × 13½	280 × 230 × 340
	ISS: Rain Collector Side with Fan-Aspirated Radiation Shield	13 × 9 × 20	330 × 230 × 510
	Leaf & Soil Moisture/ Temperature Station	5 × 2½ × 7	130 × 60 × 180
	Temperature Station	5 × 2½ × 7	130 × 60 × 180
	Temperature/Humidity Station	8¼ × 7¼ × 7¼	210 × 185 × 197
Wiz & Mon	Console	5¼ × 5¼ × 3	133 × 150 × 76
	LCD Display	4¼ × 1¼	108 × 45
	Junction Box	3¼ × 1¼ × ¾	82 × 48 × 22

Surge Protector

For upgraded protection against lightning-induced power surges, power-cross conditions, and ground potential rises, use surge protectors with any of our cabled weather stations. See the chart for the number of protectors required for your installation. Stripping of wires is required.

7767 Surge Protector



Surge Protector Shelter

Weather-resistant shelter for surge protectors (sold separately). Houses up to two surge protectors. Measures 3½" × 5¾" × 2¼" (9 × 14.5 × 5.5 cm).



7768 Surge Protector Shelter

Number of Surge Protectors Required

Weather Station	Cable Run	Number of Surge Protectors
Vantage Pro2 or Pro2 Plus	Anemometer to Integrated sensor suite	2
	Integrated sensor suite to console	2
Weather Wizard III or Weather Monitor II	Temperature sensor to junction box	1
	Rain collector to junction box	1
	Anemometer to junction box	2
	Temp/hum sensor to junction box	3
	Junction box to console	4

Estimated Current Draw & Battery Life*	Current Draw in milliamperes		Backup Battery Life in Days		80-Amp Car Battery Life at normal temperatures
	lights off	lights on	without data logger	with data logger	
Wireless Vantage Pro2 Console/Receiver	0.9	160	274	274	> 4 years
Cabled Vantage Pro2 Console & Sensors	8	168	27	27	14 months
Perception II	7	127	2.5	1.0	6 to 9 months
Weather Wizard III	6	n/a	3.0	1.5	6 to 9 months
Weather Monitor II	7	127	2.5	1.0	6 to 9 months

* Actual battery life will vary depending on station setup and usage.

Cabled Vantage Pro2 Plus

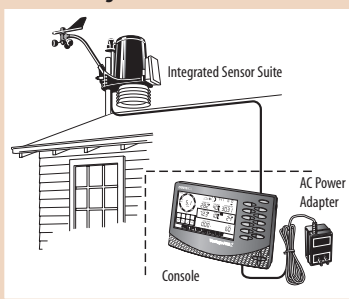

Remote Anemometer

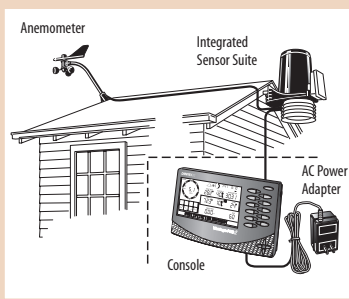

Each Vantage Pro2 console/receiver can receive data from up to eight different transmitting stations.

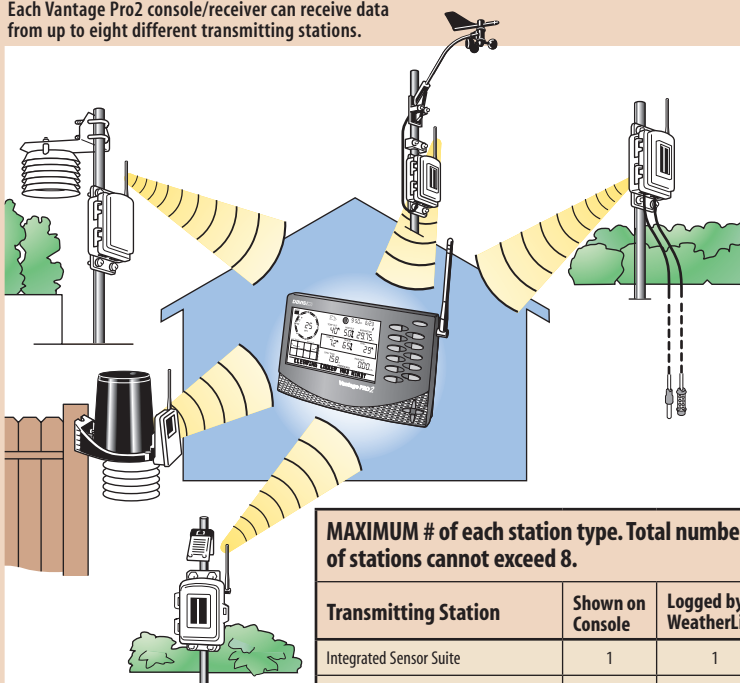

Wireless Vantage Pro2

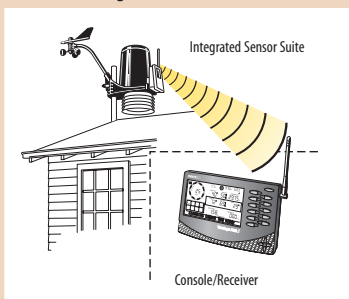

Anemometer Transmitter Kit

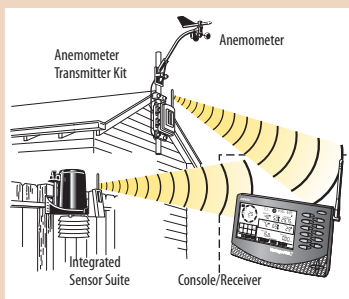

MAXIMUM # of each station type. Total number of stations cannot exceed 8.

Transmitting Station	Shown on Console	Logged by WeatherLink
Integrated Sensor Suite	1	1
Anemometer Transmitter Kit	1	1
Leaf & Soil Moisture/Temperature	2*	2*
Temperature Station	8	3**
Temperature/Humidity Station	8	2**

* One fully-populated station or two partially-populated stations; see page 8.
 ** WeatherLink will log a maximum of 3 Temperature Stations or 1 Temperature Station and 2 Temperature/Humidity Stations.

Weather Envoy with a wireless or cabled field station

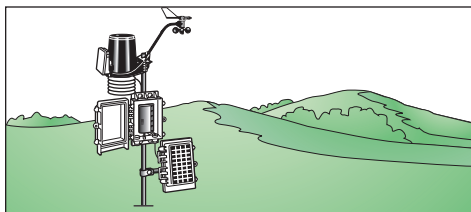

Cabled Field Station. With Multi-Purpose Shelter and 7707 Solar Power Kit.

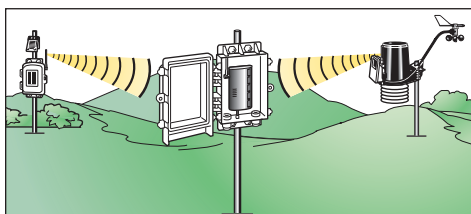

Wireless Field Station. Run on batteries or add our 6610 Solar Power Kit.

Field Station with Solar Power and Soil Moisture

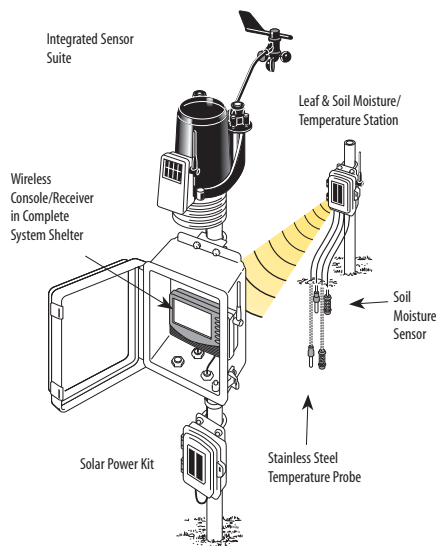

WeatherLink for Vantage Pro2

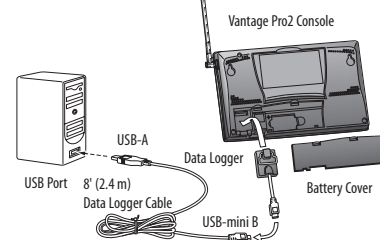

Wireless Weather Envoy

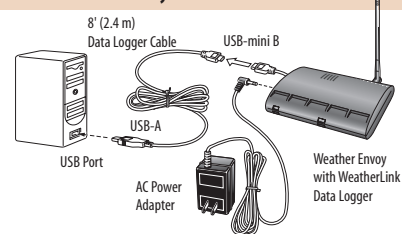

Weather Monitor II Components



Weather Monitor II Installation

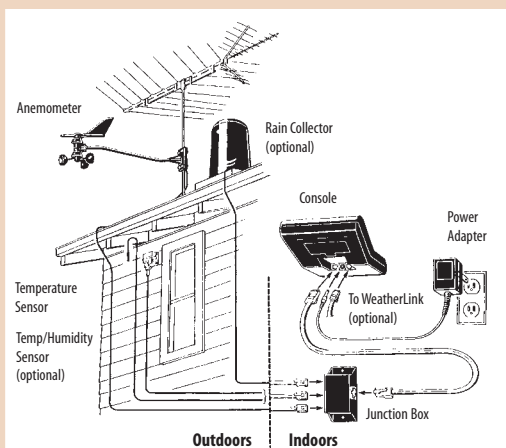

Link Isolator Kit Installation

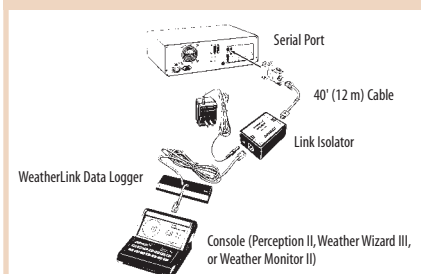

Options & Accessories

With our options and accessories, you can build your own customized weather station to suit your needs. See the chart on the prior page for the maximum number of wireless stations that can report to a single Vantage Pro2 console/receiver or Weather Envoy.



David and Bz Sommers installed a Vantage Pro Plus on the roof of their townhouse in Woodland Hills, California to keep an eye on UV levels and help guard against skin cancer.

Option or Accessory		Wireless						Cabled						Inches	Millimeters	
		6152 Vantage Pro2	6153 with Fan-Aspirated Rad Shield	6162 Vantage Pro2 Plus	6163 with Fan-Aspirated Rad Shield	6345 Leaf & Soil Moisture/Temp	6372 Temperature Station	6382 Temperature/Humidity Station	6152C Vantage Pro2	6162C Vantage Pro2 Plus	7400 Perception II	7425 Weather Wizard III	7425CS Complete Weather Wizard III	7440 Weather Monitor II	7440CS Complete Weather Monitor II	
Wireless	6312 Vantage Pro2 Console/Receiver	•	•	•	•	•	•								9 1/2 × 6 × 1 1/2	240 × 150 × 38
	6316 Wireless Weather Envoy	•	•	•	•	•	•								5 × 2 1/8 × 7	130 × 60 × 180
	6332 Anemometer Transmitter Kit	•	•	•	•										3 7/8 × 6 7/8 × 1 1/8	93 × 162 × 30
	7626 Wireless Repeater, AC Power	•	•	•	•	•	•								5 × 2 1/8 × 7	130 × 60 × 180
	7627 Wireless Repeater, Solar Power	•	•	•	•	•	•								5 × 2 1/8 × 7	130 × 60 × 180
Sensors	6420 Leaf Wetness Sensor					•									2 × 3 1/2 × 1/2	50 × 90 × 13
	7852 Rain Collector II										•	•			8 3/4 diameter × 9 1/2	165 diameter × 240
	6440 Soil Moisture Sensor					•									7/8 diameter × 2	22 diameter × 50
	6450 Solar Radiation Sensor	•	•					•							2 × 2 1/4 × 2 1/4	50 × 70 × 57
	6470 Temperature Probe, Stainless					•									1/4 diameter × 2	6 diameter × 50
	7859 Temperature/Humidity Sensor												•		3 1/2 × 3 1/4 × 1 1/4	90 × 83 × 38
6490 UV Sensor	•	•						•						2 × 2 1/4 × 2 1/4	50 × 70 × 57	
Computer Interface	6510 WeatherLink for Vantage Pro2, Windows	•	•	•	•	•	•	•	•						1 1/8 × 1 3/8 × 5/8	30 × 35 × 15
	6520 WeatherLink for Vantage Pro2, Mac	•	•	•	•	•	•	•	•						1 1/8 × 1 3/8 × 5/8	30 × 35 × 15
	6540 WeatherLink for APRS	•	•	•	•			•	•						1 1/8 × 1 3/8 × 5/8	30 × 35 × 15
	6550 WeatherLink for Emergency Response Teams	•	•	•	•			•	•						1 1/8 × 1 3/8 × 5/8	30 × 35 × 15
	6560 WeatherLink for Irrigation Control	•	•	•	•	•	•	•	•						1 1/8 × 1 3/8 × 5/8	30 × 35 × 15
	7862 WeatherLink for Wizard/Monitor, Windows										•	•	•	•	4 1/4 × 1 1/4 × 1 1/2	108 × 45 × 13
	7855 WeatherLink for Wizard/Monitor, Mac OS X										•	•	•	•	4 1/4 × 1 1/4 × 1 1/2	108 × 45 × 13
	6533 Telephone Modem Adapter	•	•	•	•	•	•	•	•						1 3/4 × 2 1/4 × 1 1/2	45 × 57 × 13
7870 Telephone Modem Adapter										•	•	•	•	1 3/4 × 2 1/4 × 1 1/2	45 × 57 × 13	
Power	6604 Car/Boat/RV Lighter Cord	•	•	•	•			•	•						3/4 diameter × 3 1/4	20 diameter × 83
	7873 Car/Boat/RV Lighter Cord									•	•	•	•		3/4 diameter × 3 1/4	20 diameter × 83
	6610 Solar Power Kit	•	•	•	•										5 × 2 1/8 × 7	130 × 60 × 180
	7707 Solar Power Kit							•	•						3 3/4 × 9 1/2 × 12 1/2	95 × 240 × 318
	7708 Solar Power Kit									•	•	•	•		10 1/2 × 16 1/2 × 1	267 × 420 × 25
Installation & Mounting Options	7716 Mounting Tripod	•	•	•	•	•	•	•	•		•	•	•	•	30 × 33 × 52	762 × 838 × 1320
	7717 Mounting Pole Kit	•	•	•	•	•	•	•	•		•	•	•	•	1 5/16 diameter × 37 1/2	33 diameter × 950
	7740 Protected Junction Box										•	•	•	•	5 3/4 × 5 3/4 × 1 1/4	145 × 145 × 32
	7714 Radiation Shield					•	•				•	•	•	•	7 1/2 × 8 1/2 × 6	190 × 215 × 152
	7704 Rain Collector Shelf										•	•	•	•	10 × 8 3/4 × 3 1/2	255 × 222 × 90
	7720 Rain Collector Heater	•	•	•	•			•	•		•	•	•	•	4 × 2 1/4 × 3 1/4	102 × 57 × 20
	6673 Sensor Mounting Shelf	•	•					•							2 × 9 × 3 1/2	50 × 228 × 2
	7702 Sensor Mounting Arm										•	•	•	•	32 × 2 × 7 3/4	813 × 50 × 197
	7767 Surge Protector	•	•	•	•			•	•		•	•	•	•	1 1/2 × 1 1/2 × 1 1/4	38 × 38 × 32
	7768 Surge Protector Shelter	•	•	•	•			•	•		•	•	•	•	3 1/2 × 5 3/4 × 2 1/4	88 × 145 × 55
	7724 Complete System Shelter	•	•	•	•			•	•	•	•	•	•	•	15 1/2 × 7 1/4 × 13 1/2	395 × 197 × 343
	7728 Multi-Purpose Shelter									•	•	•	•	•	15 1/2 × 7 1/4 × 13 1/2	395 × 197 × 343
	7747 Daytime Fan-Aspirated Radiation Shield	•	•					•	•						9 7/8 × 4 1/4	240 × 120

Sensor Accuracy, Resolution, and Range

Function		Vantage Pro2	Perception II	Weather Wizard III	Weather Monitor II	U.S.A. Units			Metric Units		
						Resolution	Range	Accuracy ±	Resolution	Range	Accuracy ±
Agricultural	Evapotranspiration	●				0.01"	Day: to 99.99" Month: to 199.99" Year: to 199.99"	5%	0.1 mm	Day: to 999.9 mm Month: to 1999.9 mm Year: to 1999.9 mm	5%
	Growing Degree-Days	○				Day: 0.1 D-Day Avg: 0.1 D-Day Total: 1 D-Day	Day: to 400 D-Days Avg: to 400 D-Days Total: to 19,999 D-Days		Day: 0.1 D-Day Avg: 0.1 D-Day Total: 1 D-Day	Day: to 220 D-Days Avg: to 220 D-Days Total: to 19,999 D-Days	
	Leaf Wetness	●				1	0 to 15	0.5	1	0 to 15	0.5
	Soil Moisture	●				1 cb	0 to 200 cb		1 cb	0 to 200 cb	
Barometric Pressure	Barometric Pressure (Elevation range: -1000' to +12,500'; -300 to +3800 m)	✓	✓		✓	0.01" Hg	26" to 32" Hg	0.03" Hg	0.1 mm Hg	660 to 810 mm Hg	0.8 mm Hg
		✓	✓		✓				0.1 mb	880 to 1080 mb	1.0 mb
		✓							0.1 hPa	880 to 1080 hPa	1.0 hPa
	Three-Hour Trend	✓				Slow ≥ 0.02" Hg Rapid ≥ 0.06" Hg	5-Position Arrow		Slow ≥ 0.5 mm (0.7 mb) Rapid ≥ 1.5 mm (2 mb)	5-Position Arrow	
One-Hour Trend		✓		✓	Change ≥ 0.02" Hg	3-Position Arrow		Change ≥ 5 mm (0.7 mb, 0.7 hPa)	3-Position Arrow		
Humidity	Inside Humidity	✓	✓		✓	1%	10% to 90%	5%	1%	10% to 90%	5%
	Outside Humidity	✓			●	1%	0% to 100%	3%	1%	0% to 100%	3%
	Dew Point	✓			●	1°F	-105° to +130°F	3°F	1°C	-76° to +54°C	1.5°C
Rainfall	Rainfall	✓				0.01"	Day: 0 to 99.99" Storm: 0 to 99.99" Month: 0 to 199.99" Year: 0 to 199.99"	4%	0.2 mm. (Rounded to 1 mm at 2000 mm and above.)	Day: 0 to 9999 mm Storm: 0 to 9999 mm Month: 0 to 19,999 mm Year: 0 to 19,999 mm	4%
				●	●	0.01"	Day: 0 to 40.95" Total: 0 to 99.99"	4%	0.2 mm	Day: 0 to 819 mm Total: 0 to 9999 mm	4%
	Rate of Rainfall	✓				0.01"	0 to 99.99"/hr	5%	0.1 mm	0 to 1999.9 mm/hr	5%
Solar & UV	Solar Radiation	●				1 W/m ²	0 to 1800 W/m ²	5%	1 W/m ²	0 to 1800 W/m ²	5%
	Solar Energy	○				0.1 Ly	1999.9 Ly	5%	PC: 0.1 J/cm ²	PC: 1999.9 J/cm ²	5%
	UV Dose	●				0.1 MEDs	0 to 199 MEDs	5%	0.1 MEDs	0 to 199 MEDs	5%
	UV Index	●				0.1	0 to 16	5%	0.1	0 to 16	5%
Temperature	Inside Temperature	✓	✓	✓	✓	0.1°F	32° to 140°F	1°F	0.1°C	0° to 60°C	0.5°C
	Outside Temperature	✓		✓	✓	0.1°F	-40° to +150°F	1°F	0.1°C	-40° to +65°C	0.5°C
	Soil or Water Temperature	●				1°F	-40° to +150°F	1°F	1°C	-40° to +65°C	0.5°C
	Outside Temp-Hum Index	✓				1°F	-40° to +135°F	3°F	1°C	-40° to +57°C	1.5°C
	Temp-Hum-Sun-Wind Index	●				1°F	-90° to +135°F	4°F	1°C	-68° to +64°C	2°C
	Wind Chill	✓		✓	✓	1°F	-110° to +130°F	2°F	1°C	-79° to +54°C	1°C
Time/Date	Time	✓	✓	✓	✓	1 minute	12 hours	8 sec/mo	1 minute	24 hours	8 sec/mo
	Date	✓	✓	✓	✓	month/day		8 sec/mo	day/month		8 sec/mo
	Sunrise & Sunset	✓				1 minute			1 minute		
Wind	Wind Direction	✓		✓	✓	1°	0° to 360°	7°	1°	0° to 360°	7°
				✓	✓	10°	0° to 360°	7°	10°	0° to 360°	7°
	Compass Rose	✓		✓	✓	22.5°	16 compass points	7°	22.5°	16 compass points	7°
	Wind Speed	✓		✓	✓	1 mph 1 knot	2 to 150 mph 2 to 130 knots	5%	0.1 m/s 1 km/hr	1 to 67 m/s, 3 to 241 km/hr	5%
	Direction of High Speed	✓				22.5°	16 compass points	7°	22.5°	16 compass points	7°

- ✓ Included
- Optional, shown on console
- Optional, requires WeatherLink

Unless listed separately, accuracy, resolution, and range are for Vantage Pro2 stations. Specifications for Perception, Wizard, and Monitor may be somewhat different. For complete specifications, visit our website at www.davisnet.com/links.

"Resolution" refers to the number of digits or decimal places displayed on the console. Our rain collector reads in true 0.01" or 0.2 mm increments. All other weather variables are measured and accumulated in U.S. units of measure, which are then converted to metric units for display purposes.

Wizard and Monitor calculate and display wind chill according to the original National Weather Service Formula. A new formula was adopted in 2001. For wind chill using this formula, view the data using WeatherLink or choose Vantage Pro2 instead.

Things to consider when Purchasing an Electronic Weather Station

1. What weather variables are measured and recorded?

Most other stations offer barometric pressure, outside humidity and dew point, daily and yearly rainfall, wind speed and direction, wind chill, and outside temperature. Some also offer inside temperature and humidity, and a few even give you extra outside temperatures and rain rate. Only Vantage Pro2 gives you all these, plus:

- Additional Rainfall Information: 15-minute, hourly, and monthly rainfall, and rainfall amounts for each of the last 24 storms.
- Additional Wind Speed Information: 10-minute average speed, direction of high speed, and 10-minute dominant wind direction.
- Apparent Temperature: Heat index and, with a solar radiation sensor, temperature-humidity-sun-wind index.
- Optional Solar and UV Radiation Sensors for greater awareness of the dangers of excessive exposure to the sun.
- For agricultural users, optional evapotranspiration, leaf wetness, soil moisture, and soil temperature.

2. How easy is it to set up?

With most competing stations, you need to install each sensor separately, which adds complication and takes time and effort. Vantage Pro2 is factory-assembled to make setup as easy as possible. Just complete a few minor assembly steps, insert the battery, and you're ready to mount the sensor suite. Mount the two sides together using our optional tripod, or detach the anemometer to mount it separately. Flexible mounting options make it easy, either way.

3. What is the maximum transmission distance?

The wireless transmission range for most competing stations is generally quite limited. Although range is highly variable (depending not only on the physical features of the land and structure but also on RF interference in the area), Vantage Pro2 will almost always out perform the competition. And—unlike the competition—we offer wireless repeaters should you wish to extend the range even further.

4. How many highs and lows are measured and recorded?

Most other stations simply give you the current readings. If highs and lows are available at all, they are usually quite limited. Only Vantage Pro2 gives you the highs and lows (and/or totals or averages) for just

about all weather conditions, with time and/or date for the last 24 days, months, or years. No other station on the market even comes close. And not only can you view the data numerically, you'll can also view on-screen graphs, for instant visual representations of long-term trends.

5. How often is the information updated?

The Vantage Pro2 transmitter sends data to the console every 2½ seconds. Highly variable conditions (such as wind speed and direction) are updated with each packet, while less variable conditions are updated every 10 seconds. With competing stations, the update interval is much longer: 30 seconds, or even up to 3 minutes. This may



In Antarctica, researchers from Stanford University installed two Davis weather stations: one at Dronning Maud Land, and a second at Patriot Hills a few years later. To view the weather reported by these stations, see <http://thistle.org/ALE/>.

not seem important. But try watching the wind gust, or the rain suddenly come pouring down. It's very disconcerting to look out the window, see something happen weather-wise, and not see it reflected on the console right away.

6. How is the forecast generated?

The competition generally bases their forecast on barometric pressure alone, which results in none too accurate a prediction. Vantage Pro2 uses a sophisticated forecasting algorithm which takes into account not only barometric pressure, but also wind, rainfall, temperature, humidity, and longitude and latitude. The result? A much more accurate forecast. Not perfect, but even the guys with the satellite pictures don't always get it right!

7. How is the forecast displayed?

Competing stations use icons to show the forecast. Vantage Pro2 has similar icons, plus over 80 different forecast messages that scroll across the bottom of the display.

None of the other stations have this. The ticker tape also gives additional information depending on which key you press. Press WIND to display wind speed, and you'll get a message showing the 10 minute average wind speed. If it's raining, press RAIN YR to see the last 15 minutes of rain, or RAIN DAY to see the last 24 hours of rain. And these are just a few examples! None of the competing stations have anything like this.

8. How much data can you graph on the screen?

With Vantage Pro2, you can graph just about every weather variable, with averages and highs and lows for most, and go back in time for minutes, days, months, and years. The competition typically graphs just

software package. The data logger stores data at the interval you choose (from one minute to two hours) for up to six months. Transfer the data whenever you like, or leave your computer on to have it transfer automatically every day. For some competing stations, no software package is available. Other stations do offer software, but don't include a data logger—so your PC must be on and the software running at all times.

11. How many alarms are there?

With Vantage Pro2, alarms can be set for just about every weather variable, for just about any reason imaginable—up to 70 alarms in all. The alarms found on competing stations are generally quite limited.

12. What is the accuracy, resolution, and range?

Vantage Pro2 generally beats the competition in accuracy, resolution, and range. It can be difficult to find the specs for competing stations. When we do find them, our testing shows that they are a bit, shall we say, optimistic. We are proud to publish our specs in our catalog and on our website, and stand behind them 100%.

13. How many people are using the stations?

Although Vantage Pro2 is new, there are many thousands of happy Davis weather station users around the country and around the world. Check out "Weather World Round" on our website (www.davisnet.com/links), and you'll see a listing for Norman, Oklahoma. Click on the link, and you'll go to the website for the National Weather Service's Storm Prediction Center. They're using our Weather Monitor II to update the local "unofficial" weather conditions to their website. Many other Davis weather station owners participate as volunteer observers for the National Weather Service, the National Hurricane Center, and numerous local TV and radio stations.

14. How long has the company been in business?

In business since 1963, Davis Instruments opened up the home weather station market back in 1989. Our weather stations are manufactured right here in Hayward, California, and we have a full customer service and support staff. Most competing stations are made overseas, and it can be difficult (if not impossible) to get any kind of customer service or aftermarket support.

one variable—barometric pressure—and typically just for the last 24 hours. With all the graphs on Vantage Pro2, you can do tons of analysis, even without purchasing a software package. You'll find that the more dramatic the weather is, the more fun it is to look at the graphs. Just how windy is it, and how does it compare to the last wind storm? How much rain did we get this month, as compared to last month?

9. Can you use the station at higher elevations?

Our stations can be used up to 12,500 feet in elevation. Many competing stations are limited to 6,000 feet or below. If you're lucky enough to live and work—or perhaps enjoy a vacation home—in the mountains, you'll find that our Vantage Pro2 weather station works just fine, no matter what the elevation.

10. Is there a computer interface?

If you'd like to do even more analysis, add our WeatherLink data logger and

With state-of-the-art technology at affordable prices, Davis weather stations are used in a variety of ways, all over the world. Here's just a sampling of the many stories and photos we've received. Got a story to share? We'd love to hear it. Send your story or photo to news@davisnet.com. If we use it in our catalog or e-newsletter, we'll send you a free Davis hat or T-shirt.



In Val Gardena, Italy, Stuessler Patrick helped install a Vantage Pro weather station atop the 2450 m (8040') high Mount Seceda, where blustery winds and low temperatures are not uncommon. Now, both tourists and locals alike can keep tabs on the weather at www.valgardena.it.



Carol Clement of Heather Ridge Farm in Schoharie County, New York, keeps a Davis station in the field alongside her beehives. According to Carol, "Bees don't like weather change—they get very cranky!"



Oklahoma storm chaser Chris Caldwell has not just one Davis weather station, but three—one at home, one at the lake, and one on his storm chasing vehicle, which attracts attention wherever he goes.



At the family-run Ho'olawa Farms native plant nursery on the island of Maui, Hawaii, Chane Miller relies on Vantage Pro to help schedule irrigation and pest control.



On the Barrington River in Rhode Island, William Harris has both a Vantage Pro and a Wireless Temperature Station. The station tells him if the water is right for swimming in the summer, and warns of ice formation in the winter.



Michael Hill of Shawano, Wisconsin, snapped this photo of his Vantage Pro Plus with Fan-Aspirated Radiation Shield in winter. Michael writes, "It keeps on working even through the worst weather!"

Weather Club E-Newsletter

Like to learn more? Our e-newsletter is chock full of interesting stories, tips on maintenance and installation, and timely reminders. And it's delivered right to your PC every month. Sign up at www.davisnet.com/links.

Vantage Pro2 Features & Warranty

With Vantage Pro2, you get highs and lows (and/or totals or averages) for just about all weather conditions with time and/or date for the last 24 days, months, or years.		BAR		HUMIDITY			RAIN			TEMPERATURE				WIND			WITH OPTIONAL SENSORS							
		Barometric Pressure	Inside Humidity	Outside Humidity	Dew Point	Rainfall Amount	Rain Storm Amount	Rain Rate	Inside Temperature	Outside Temperature	Heat Index	Wind Chill	Wind Speed	Wind Direction	Direction of High Speed	Evapotranspiration	Humidity (Extra)	Leaf Wetness	Soil Moisture	Solar Radiation	Temperature (Extra)	Temp-Hum-Sun-Wind	UV Radiation	UV MEDS
Update Interval *		15 min	1 min	50 sec	10 sec	10 sec	10 sec	1 min	10 sec	10 sec	10 sec	2½ sec	2½ sec	2½ sec	1 hour	50 sec	15 sec	60 sec	50 sec	10 sec	10 sec	50 sec	50 sec	
CONSOLE DISPLAYS																								
Reading at end of update interval		•	•	•	•				•	•	•	•		•			•	•	•	•	•	•	•	•
Total amount for the interval						•	•								•									•
Average reading for the interval													•											
High reading for the interval								•																
SET ALARMS for																								
Special Alarms		①				②	③							④										⑥
High Reading			•	•	•			•	•	•	•			•			•	•	•	•	•	•	•	•
Low Reading			•	•	•				•	•						•	•	•		•				
DISPLAYED but not graphed																								
Current Year High		•	•	•	•				•	•						•	•	•		•				
Current Year Low		•	•	•	•				•			•				•	•	•		•				
GRAPHED & DISPLAYED for last 24 of each of the following																								
EOP	End-of-15-Minute Period Readings	•																						
	End-of-Hour Period Readings	•	•	•	•				•	•	•						•	•				•		
TOTALS	15-minute Period Totals					•																		
	Hourly Totals					•										•								•
	Daily Totals					•										•								•
	Monthly Totals					•										•								
	Storm Totals (with start & end date)						•																	
	Yearly Totals					•										•								
AVERAGES	10-Minute Averages												•											
	Hourly Averages or Dominant											•	•					•					•	
	Daily Averages or Dominant												•	•										
	Monthly Averages or Dominant												•	•										
	Yearly Averages													•										
HIGHS	One-Minute Highs							•																
	Hourly Highs							•					•											
	Daily Highs	•	•	•	•			•	•	•	•			•			•	•	•		•	•	•	•
	Monthly Highs	•	•	•	•			•	•	•	•			•			•	•	•		•	•	•	•
	Yearly Highs							•					•											
LOWS	Hourly Lows												•											
	Daily Lows	•	•	•	•			•	•		•						•	•						
	Monthly Lows	•	•	•	•			•	•		•						•							
	Yearly Lows										•													

* Update interval may vary depending on station ID and type of station.

SPECIAL ALARMS

- ① Storm Warning: Amount of barometric pressure fall. Storm Clearing: Amount of barometric pressure rise.
- ② Flash Flood Warning: 15-minute rainfall amount. 24-Hour Rain Alarm: 24-hour rainfall amount.
- ③ Rainstorm Alarm: Rainfall amount for current storm.

- ④ 10-Minute Average Wind Speed Alarm
- ⑤ Daily Evapotranspiration Amount Alarm
- ⑥ Daily UV Dose Alarm

Warranty

We warrant our products to be free of defects in material and workmanship for one year from date of original purchase. While we make every effort to carefully manufacture our products to the highest standards of quality, occasionally parts may be found to be missing, defective, or damaged. If you have a defective part, return the product to us, shipping charges prepaid. Include proof of purchase and a written explanation of the trouble. During the warranty period, we will, at our option, either repair or replace the product free of charge. This warranty does not cover damage due to improper installation or use, lightning, negligence, accident, or unauthorized service, or to incidental or consequential damages beyond the Davis products themselves. Implied warranties are limited in duration to the life of this limited warranty. Some states do not allow limitations on how long an implied warranty lasts, or the exclusion or limitation of incidental and consequential damages, so the above limitation may not apply to you. This warranty gives you specific legal rights. You may have other rights, which vary from state to state or country to country.

Details, specifications, and prices are subject to change at any time without notice.

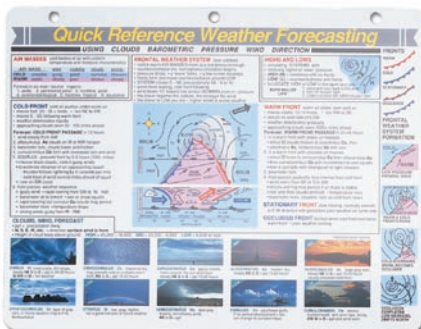

Weather Forecasting Card

Discusses the use of wind direction, barometric pressure, and cloud type in predicting the weather. Includes full list of radio weather stations for official broadcasts, plus key information on storm warnings, hurricane avoidance, navigating in fog and other hazardous conditions, and more. Weatherproof high-strength plastic, full color both sides. Punched for binder or bulkhead mounting. Dimensions: 8½" x 11" (216 x 279 mm).

131 Weather Forecasting Card

Davis Hat

Now you can get your own Davis hat! Baseball-style cap is 100% cotton twill. Two-toned with washed khaki crown, dark-colored brim, and embroidered Davis logo. Self-fabric closure with brass buckle. One size fits all.



PR725 Davis Hat

In addition to weather stations, Davis Instruments also has a complete line of vehicle monitoring systems. First introduced in 1994, our DriveRight on-board consoles and Fleet Management Software are used by business and industry around the world. Now, with the introduction of CarChip, that same powerful data logging is available to you.

NEW! CarChip®

Don't wait for a speeding ticket—or worse—to find out how your teen is driving. CarChip plugs instantly into the OBDII (on-board diagnostics) port in your car or truck, where it continuously logs vehicle and driver performance. Download the data to your PC, and you'll get complete details for each trip plus details on engine performance when and if the vehicle's check engine light comes on. Stores up to 75 hours of driving data.

8211 CarChip



Trip log includes:

- Time & Date
- Distance
- Average Speed
- Maximum Speed
- Hard Brakings
- Quick Accelerations

Speed is recorded every 5 seconds. Hard brakings are highlighted in red, quick accelerations in blue.

Trouble log shows diagnostic trouble code and description plus additional details on engine performance.

Accident log shows the speed for each of the last 20 seconds before coming to a complete stop. (E/X model only.)

Oxygen sensor voltage is just one of the 23 selectable engine parameters you can choose to monitor. (E/X model only.)

NEW! CarChipE/X®

By detecting malfunctions early and taking the guesswork out of diagnosing problems, CarChipE/X can help you keep your car in peak running condition. Log any 4 out of 23 possible engine parameters, each of which can affect operation, emissions, and fuel economy. Choose standard CarChipE/X or CarChipE/X with Alarm, with user-settable alarms for speed, hard braking, and quick acceleration. Stores up to 300 hours of driving data.

8221 CarChipE/X

8225 CarChipE/X with Alarm



Installation couldn't be easier.

- 1. Locate your car's OBDII connector.** You'll find it inside the car, no more than 3 feet from the driver's seat.
- 2. Plug the data logger in.** The blinking light tells you it's installed and ready to go.
- 3. Start driving.** CarChip will start collecting data your very next trip. Later, download to your PC for analysis, graphing, and charting.



CarChip Fleet

CarChip is also available in a fleet model with additional reporting capabilities specially designed for fleet managers. For more information, ask for our full-line DriveRight catalog.



CarChip	CarChipE/X	Software lets you:														
<p>Records 75 hours of trip details:</p> <ul style="list-style-type: none"> • Time and date for each trip. • Distance traveled. • Speed (logged every five seconds). • Idle time. • Hard accelerations and decelerations. • Engine diagnostic trouble codes plus the status of engine parameters at the time the codes occurred. • Time and date every time CarChip is connected or disconnected. 	<p>Records 300 hours of trip details:</p> <ul style="list-style-type: none"> • All the features of CarChip. • Up to 4 out of 23 possible engine parameters, recorded every 5 to 60 seconds. Choose from: <table border="0" style="width: 100%;"> <tr> <td>RPM</td> <td>Battery voltage</td> </tr> <tr> <td>Throttle position</td> <td>Timing advance</td> </tr> <tr> <td>Engine load</td> <td>Coolant temperature</td> </tr> <tr> <td>Fuel pressure</td> <td>Air flow rate</td> </tr> <tr> <td>Fuel system status</td> <td>Intake air temperature</td> </tr> <tr> <td>Short-term fuel trim</td> <td>Intake manifold pressure</td> </tr> <tr> <td>Long-term fuel trim</td> <td>O₂ sensor output voltage</td> </tr> </table> 	RPM	Battery voltage	Throttle position	Timing advance	Engine load	Coolant temperature	Fuel pressure	Air flow rate	Fuel system status	Intake air temperature	Short-term fuel trim	Intake manifold pressure	Long-term fuel trim	O ₂ sensor output voltage	<ul style="list-style-type: none"> • Review and clear diagnostic trouble codes. • View summary and detail reports for each trip, including vehicle speed every 5 seconds. • Set thresholds for speed, acceleration, and braking, and view the number of times these thresholds were exceeded. • Copy data to spreadsheets and text documents for further analysis. <p>System requirements:</p> <ul style="list-style-type: none"> • Windows 98SE/2000/ME/XP and USB port.
RPM	Battery voltage															
Throttle position	Timing advance															
Engine load	Coolant temperature															
Fuel pressure	Air flow rate															
Fuel system status	Intake air temperature															
Short-term fuel trim	Intake manifold pressure															
Long-term fuel trim	O ₂ sensor output voltage															

For most cars and trucks sold in the USA and Canada, model-years 1996 or later. For a list of excluded vehicles, visit www.carchip.com. Vehicles sold outside the USA and Canada may or may not be compatible.

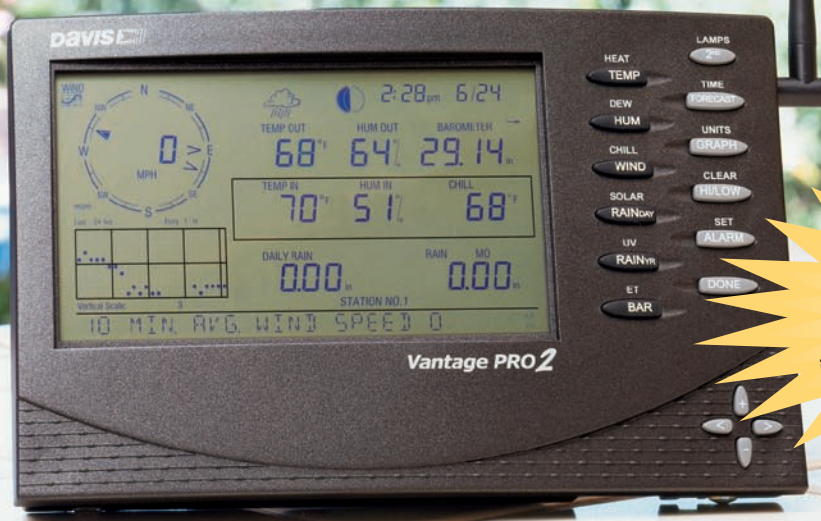

TECHNOLOGY BREAKTHROUGH!
 The first & only weather stations in their class to use frequency hopping spread spectrum radio technology.

INTRODUCING

Vantage Pro2™

- Transmits weather data wirelessly up to 1000'!
- Over 3 times the distance of competing stations!

• **Barometric Pressure.** Currently and for each of the last 24 hours. Five-position trend arrow shows whether pressure is rising, falling, or stable.



- **Temperature.** Inside and outside temperature, currently and for each of the last 24 hours. High and low temperature alarms.
- **Humidity.** Inside and outside humidity, currently and for each of the last 24 hours. High and low humidity alarms.
- **Rain.** Rainfall for the last 15 minutes and the last 24 hours, days, months, and years. Flash flood and 24-hour rain alarms.
- **Rain Rate.** Currently and for each of the last 24 minutes. Rain rate alarm.
- **Rain Storm.** Rainfall for the last 24 storms, with beginning and ending dates for each storm. Rain storm warning and alarm.

- **Wind Speed.** Current wind speed. Average for the last ten minutes and each of the last 24 hours. High and average wind speed alarms.
- **Wind Direction.** Currently and for the last 24 hours, days, and months. Direction of high wind speed.
- **Wind Chill.** Current wind chill. Wind chill alarm.
- **Dew Point.** Currently and for each of the last 24 hours. High and low dew point alarms.
- **Heat Index.** Currently and for each of the last 24 hours. Heat index alarm.
- **Sunrise & Sunset.** Time of sunrise and sunset at your location—it even takes daylight savings time into account!

- **Highs & Lows.** For most weather variables, with time and/or date, for each of the last 24 hours, days, months, and years.
- **Optional Sensors.** For UV and solar radiation, evapotranspiration, soil moisture, and more.
- **On-screen graphing.** Graph current conditions, averages, or highs and lows for the last 24 hours, days, months, or years.
- **Your own local forecast.** Forecast icons show sun, part sun, clouds and rain, or snow. Check the scrolling ticker-tape for more details.

All this—and much more—in a station that's easy to set up and fun to use.



3465 Diablo Avenue, Hayward, CA 94545-2778 USA